

## 球测头

(mm)

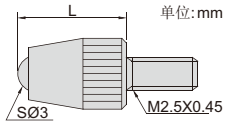

6282-0101



型号	测量面材质	L
6282-0101	硬质合金	7.3
6282-0103	陶瓷	7.3
6282-0104	硬质合金	8.3
6282-0106	硬质合金	12.1
6282-0107	硬质合金	14
6282-0108	硬质合金	15
6282-0109	陶瓷	15
6282-0110	硬质合金	17
6282-0111	硬质合金	19.3
6282-0112	硬质合金	20
6282-0113	陶瓷	20
6282-0114	硬质合金	22
6282-0115	硬质合金	25
6282-0116	陶瓷	25
6282-0117	硬质合金	30
6282-0118	陶瓷	30



6282-0301

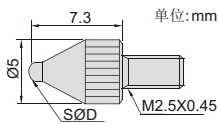

型号	测量面材质	SØD
6282-0301	钢	1
6282-0302	硬质合金	1.5
6282-0303	硬质合金	1.8
6282-0304	硬质合金	2.5
6282-0305	硬质合金	4

## 壳型测头

(mm)



6282-0202

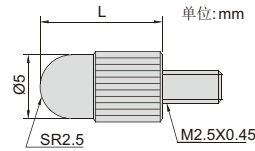

型号	测量面材质	L
6282-0202	钢	5
6282-0203	钢	10
6282-0205	钢	15
6282-0207	钢	20
6282-0208	钢	25
6282-0210	钢	30

## 球面测头

单位: mm



6282-0401

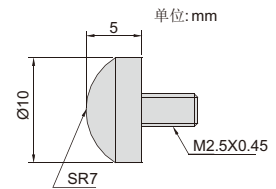

型号	测量面材质
6282-0401	钢

## 锥型测头



6282-0601

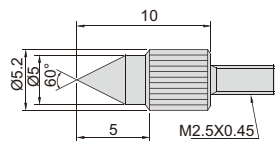

6282-0801

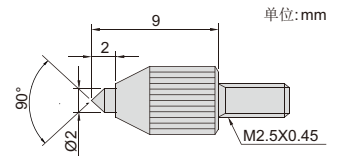

6282-0701

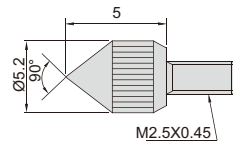

6282-0901

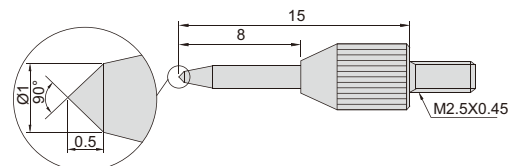

型号	测量面材质
6282-0601	钢
6282-0701	钢
6282-0801	钢
6282-0901	钢

## 平测头



6282-1101

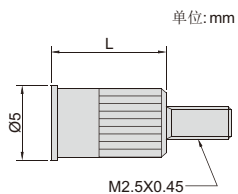

(mm)

型号	测量面材质	L
6282-1101	钢	8
6282-1102	钢	10

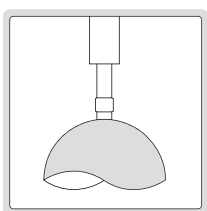

6282-1201

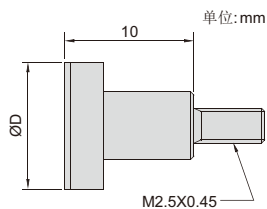

(mm)

型号	测量面材质	ØD
6282-1201	钢	10
6282-1202	钢	15
6282-1203	钢	20
6282-1204	钢	25
6282-1205	钢	30



6282-1301

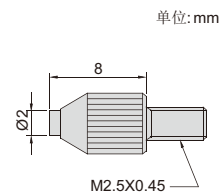

单位:mm

型号	测量面材质
6282-1301	硬质合金

## 针测头



6282-1711

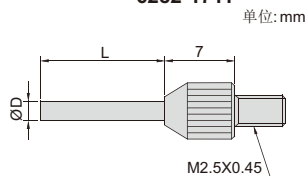

单位:mm

(mm)

型号	测量面材质	ØD	L
6282-1701	钢	0.45	3
6282-1702	钢	0.45	5
6282-1703	硬质合金	1	3
6282-1704	硬质合金	1	5
6282-1705	硬质合金	1	8
6282-1706	硬质合金	1	10
6282-1707	硬质合金	1	20
6282-1708	硬质合金	1	40
6282-1709	硬质合金	1.5	5

(mm)

型号	测量面材质	ØD	L
6282-1710	硬质合金	1.5	10
6282-1711	硬质合金	1.5	13
6282-1712	硬质合金	1.5	20
6282-1713	硬质合金	1.5	40
6282-1714	硬质合金	2	8
6282-1715	硬质合金	2	18
6282-1716	硬质合金	2	28
6282-1717	硬质合金	2	40

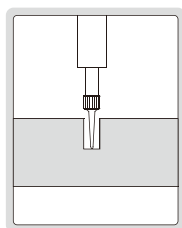

6282-1601

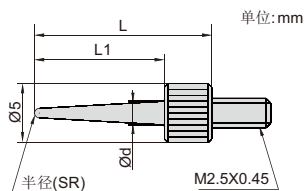

单位:mm

(mm)

型号	测量面材质	L1	L	SR	Ød
6282-1601	钢	11	15	0.4	2
6282-1602	钢	13	17	0.2	2
6282-1603	钢	21	25	0.4	3
6282-1604	钢	31	35	0.4	3

## 刀口测头

型号	测量面材质
6282-1001	钢

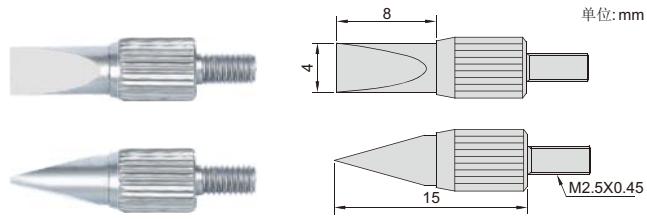

6282-1001

## 薄片测头

(mm)

型号	测量面材质	D	W
6282-1801	钢	0.4	2
6282-1802	钢	0.6	2
6282-1803	钢	1	4

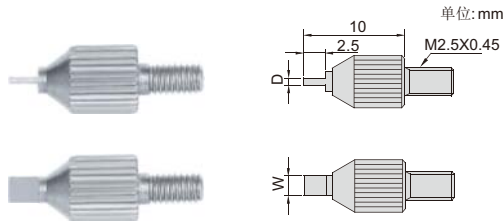

6282-1801

## 滚轮测头

型号	测量面材质
6282-1901	钢

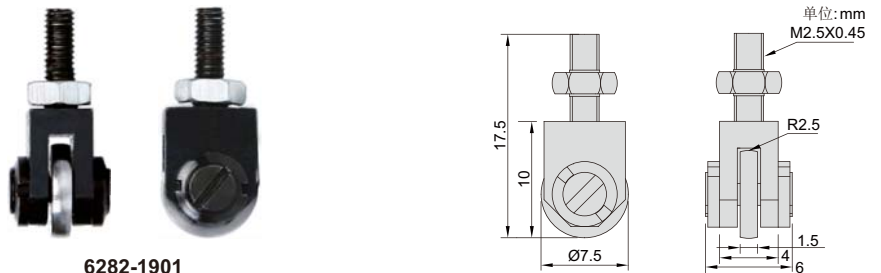

6282-1901

## 杠杆式测头



不导磁硬质合金测头

■ 可选配件: 杠杆表测针  
(型号6284-4x, 6284-5x系列)

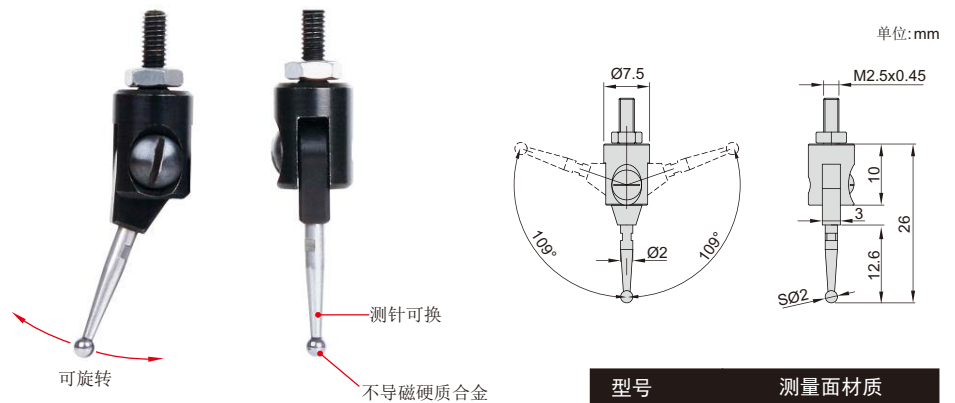

6282-2101

型号	测量面材质
6282-2101	不导磁硬质合金

## 延长杆



6282-2010

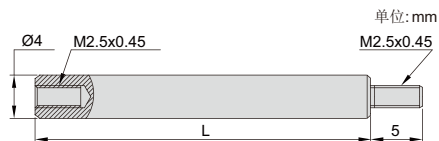

(mm)

型号	材质	L
6282-2001	钢	10
6282-2002	钢	15
6282-2003	钢	20
6282-2004	钢	25
6282-2005	钢	30
6282-2006	钢	35
6282-2007	钢	40
6282-2008	钢	45
6282-2009	钢	50

(mm)

型号	材质	L
6282-2010	钢	55
6282-2011	钢	60
6282-2012	钢	65
6282-2013	钢	70
6282-2014	钢	75
6282-2015	钢	80
6282-2016	钢	90
6282-2017	钢	100



6282-S6

型号	测量面材质
6282-S6	钢

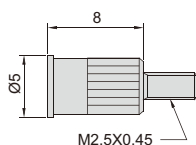

平测头

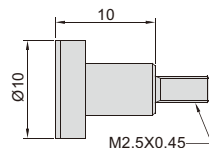

平测头

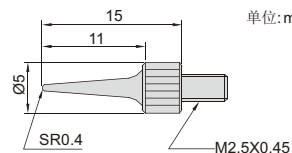

针测头

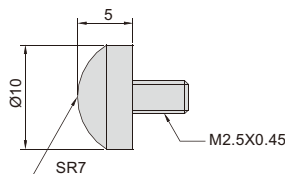

球面测头

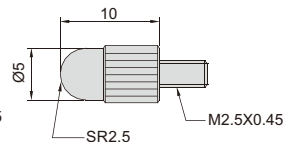

壳型测头

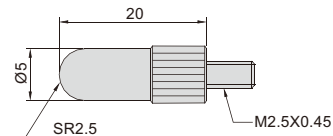

壳型测头

## 测头套装

单位: mm